

Plan XV

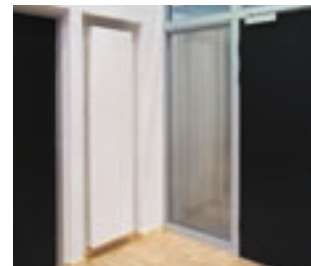

Plan XV

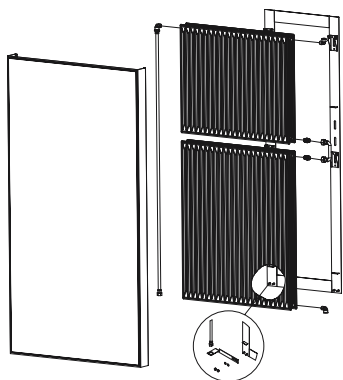

Plan XV

Plan XV

Height and length

Plan XV, profile

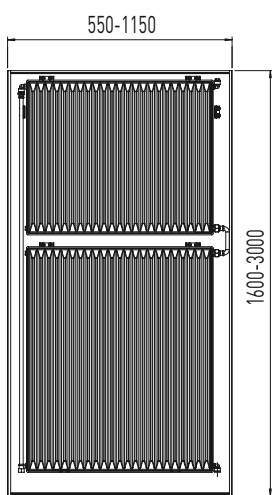

Plan XV - with built-in valve

Built-in valve format 1 (bottom), rear view

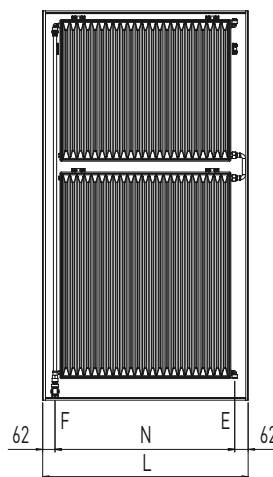

Built-in valve format 1 (top), rear view

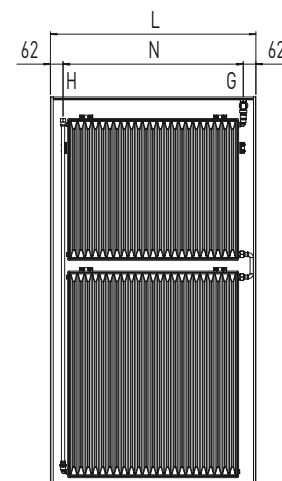

Built-in valve format 3 (bottom), rear view

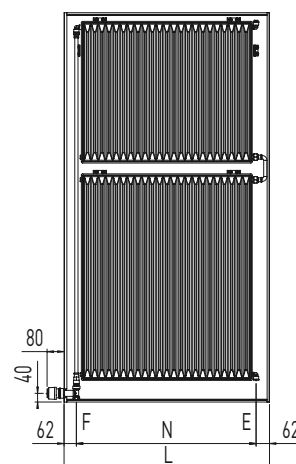

Built-in valve format 3 (top), rear view

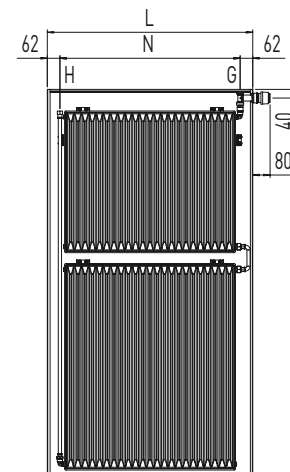

Length	550-1150 mm, in increments of 100 mm The front panel is 150 mm longer than the concealed radiators
Height	1600-3000 mm, in increments of 100 mm The front panel is 190-280 mm higher than the concealed radiators
Depth	86, 116 and 173 mm, suitable for RIOpanel type 21, 22 and 33 respectively
Tappings	1/2" standard

Mounting	Wall mounted (mounting frame is included)
Colour	Powder coated in white RAL 9010 Option: Painted in other standard RAL and BS colours
Options	- Front panel with special dimensions, please contact Hudevad - Other combinations of front panel and radiators, please contact Hudevad

Plan XV



Output

Plan XV		Output Watts/section at 75°/65°/20°			
Height mm	Radiator height	Depth, mm			Output reduction %
		86 Type 21	116 Type 22	173 Type 33	
1600	455+955	105.7	133.7	192.7	13.5
1700	555+955	112.6	142.3	205.7	15.0
1800	655+955	119.0	150.3	217.4	16.5
1900	455+555+655	137.3	170.5	246.5	18.0
2000	555+555+655	144.2	178.9	259.2	19.0
2100	555+655+655	150.6	187.0	271.2	20.5
2200	655+655+655	156.8	195.0	282.9	21.5
2300	555+555+955	158.7	199.3	288.3	23.0
2400	555+655+955	164.9	207.3	300.0	24.0
2500	655+655+955	171.2	215.4	311.7	25.0
2600	455+955+955	172.4	219.0	316.1	26.0
2700	555+955+955	179.3	227.6	328.8	27.0
2800	655+955+955	185.7	235.6	340.8	27.5
2900	655+655+655+655	209.0	259.9	377.2	28.5
3000	555+555+655+955	210.9	264.2	382.6	29.0

Mounting frame

Mounting frame with front panel outline

Mounting frame outline

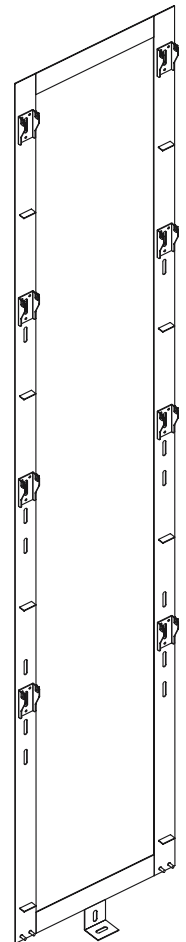
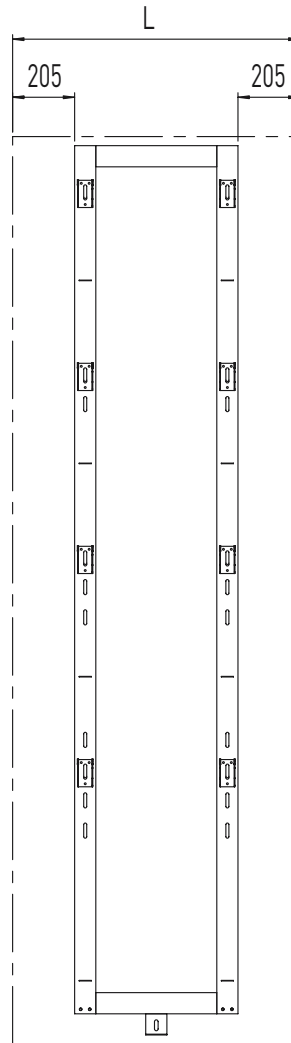

Build-in dimensions

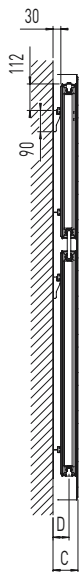

Wall dimensions		
Plan XV, depth, mm	D mm	C mm
86	68	106
116	83	136
173	83	193

Tapping designation



Tapping designation

Weight

Weight table for Plan XV, kg/metre (height)

Depth mm	Radiator type	Length						
		550	650	750	850	950	1050	1150
86	21	30.3	36.0	41.7	47.4	53.1	58.9	64.6
116	22	34.4	40.9	47.5	54.0	60.6	67.2	73.7
173	33	45.5	54.3	63.3	72.2	81.1	90.0	99.0